

27 x 1 ▽ Recess For Label
Which Is Positioned After
Bolt Is Fully Tightened

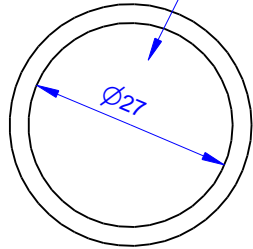

Profile To Match
Existing Knobs

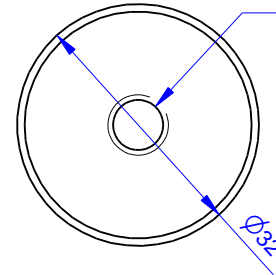
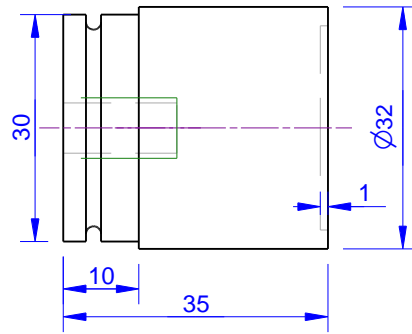

Knob
Aluminium

Coarse Straight Knurl

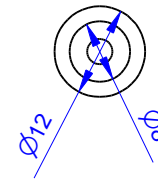
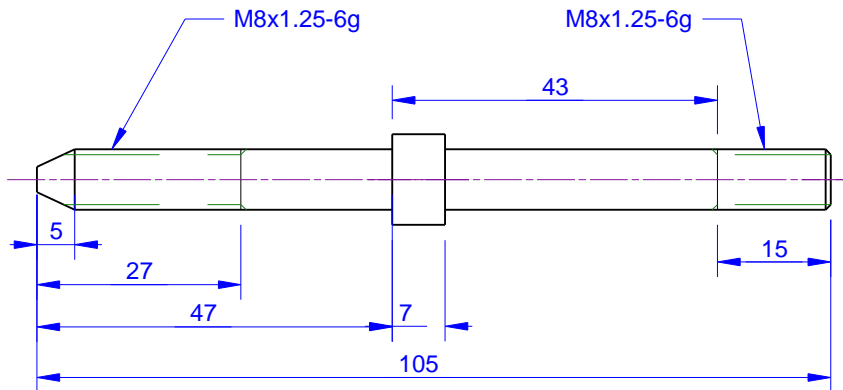
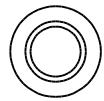
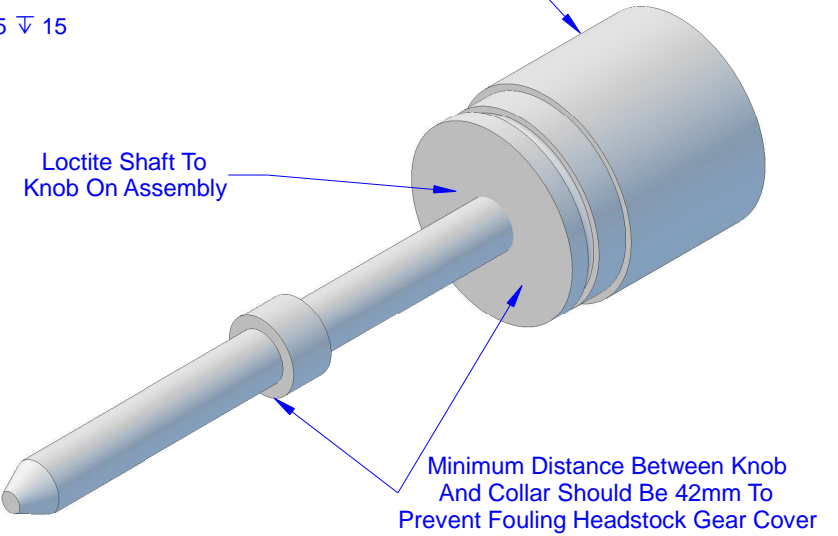

Shaft
Mild Steel