

Check Dimensions Against  
Your Lathe

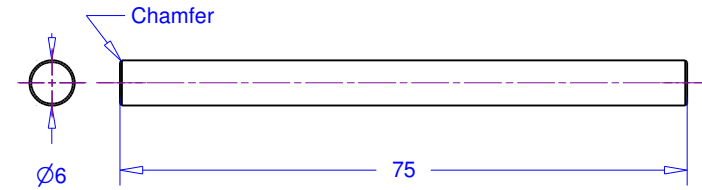

Stop Bar (1off M.S.)

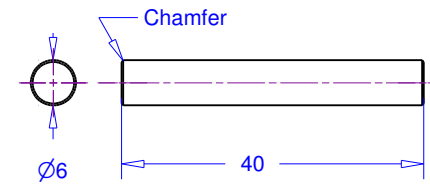

Tommy Bar (1off M.S.)

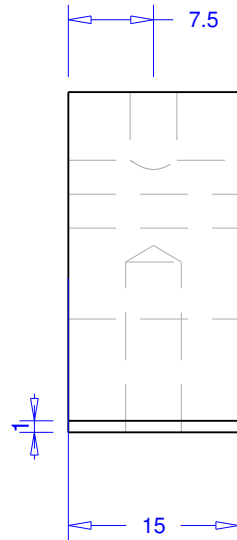
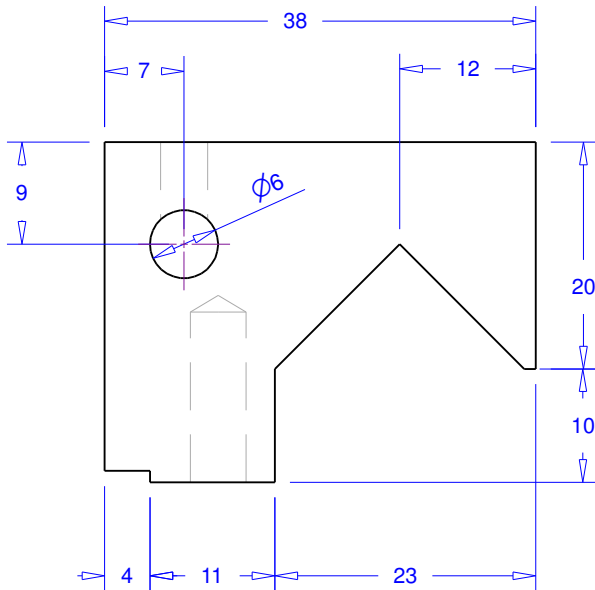

Saddle Clamp  
Body (1off M.S.)

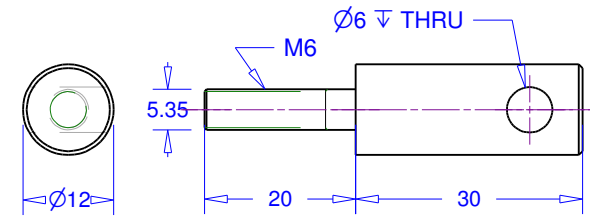
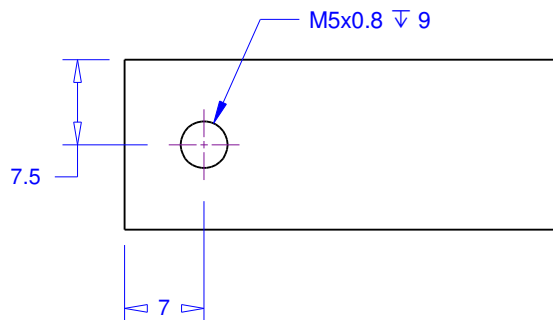

Clamp Screw (1off M.S.)

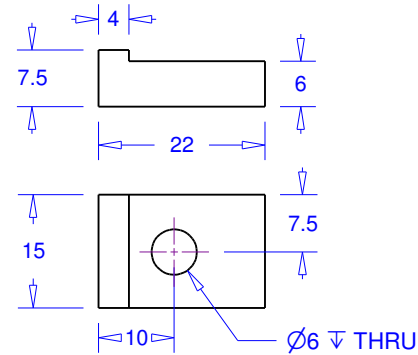

Clamp Plate  
(1off M.S.)

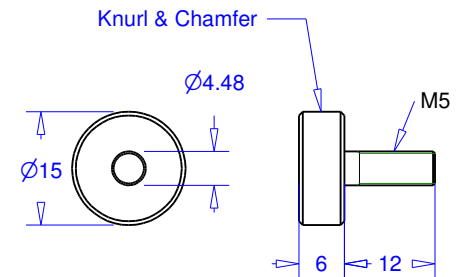

Stop Bar  
Clamp Screw  
(1off Brass)